

# Roller shutters and roller grilles

FEATURING THERMOTECK  
EXCELLENCE IN SECTIONAL STEEL



In accordance  
with the provisions  
of EN 13241-1



WE OPEN THE DOORS FOR PROGRESS



# Corporate philosophy at Teckentrup

WE OPEN THE DOORS FOR PROGRESS ...

Future-oriented innovations and continual system improvements are an inherent part of the Teckentrup corporate philosophy. Thanks to its innovative solutions and creative technology, Teckentrup is constantly setting new benchmarks in the production of doors and door systems. Prime examples of this are the challenging areas of fire safety, smoke protection, sound insulation, security and heat insulation. Teckentrup special doors and door systems are orientated

towards utility value, satisfying even the highest of demands with regard to the latest technology, design and quality. Top-grade materials, precise workmanship and continual quality control checks in accordance with DIN ISO 9001 guarantee first-rate safety, reliability and durability. This is what makes each and every Teckentrup product a well-worth investment.

Standard Teckentrup roller shutters and roller grilles comply with the safety requirements of current European standards.

Teckentrup roller shutters and roller grilles comply with the provisions of EN 13241-1.

- Mechanical aspects
- Utility reliability
- Heat insulation
- Sound insulation
- Weather-resistance
- Wind pressure



## INNOVATIVE, FLEXIBLE, RELIABLE

### Teckentrup roller shutters – customized door systems for affordable solutions

This well-developed door system is marked by its cost-effectiveness, robustness and simple design. Thanks to the space-saving roller technology and the hard-wearing roller door curtain, Teckentrup roller shutters are particularly suitable for use in high and, especially, wide areas which have to withstand tough everyday conditions.

Thanks to the flexible design concept, any individual requirements can be met, even in very tight spaces.

### ThermoTeck roller door

With heat-insulated micro-section surface page 6

- Other roller door sections and roller grilles page 8
- Colour and lighting page 10
- Side doors page 11
- Technology/Installation page 12

### ThermoTeck High-speed roller door

- For fast opening and closing page 14

### Roller shutters/ roller grilles with tubular drive

- Drive integrated in the roller tube
- Low lateral space requirements page 15

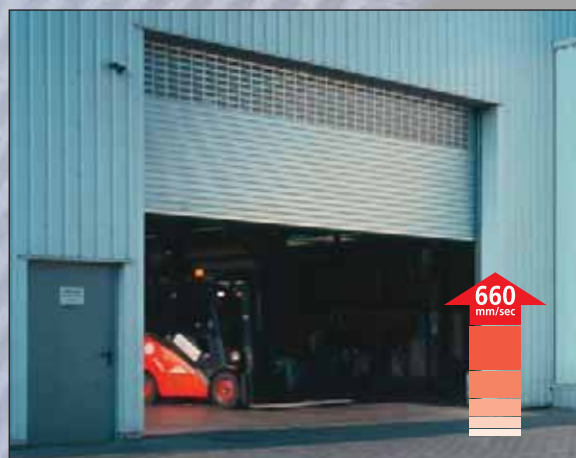

# Flexibility

FOR OPTIMUM SOLUTIONS

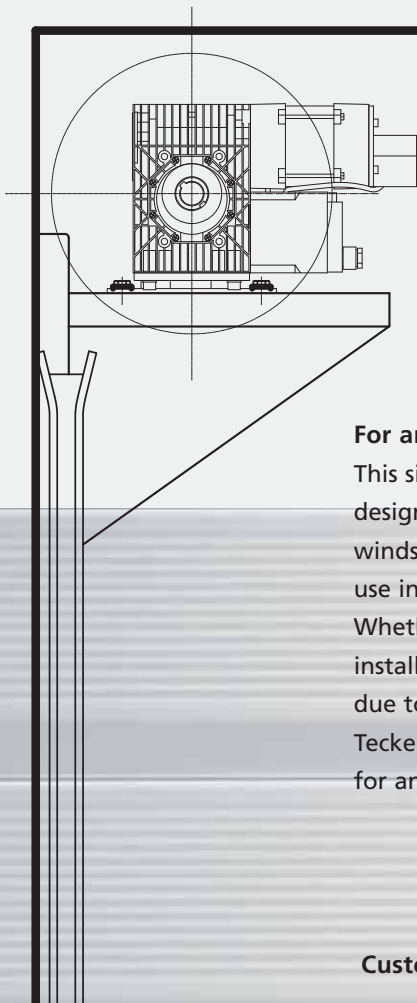

## For any architectural style

This simple, robust and flexible design featuring a roller curtain that winds up very tightly is suitable for use in a wide range of applications. Whether as outside roller shutters or installed inside, laterally or overhead due to tight space conditions, Teckentrup roller shutters are suitable for any constructional situation.



Custom-made solutions for oversized dimensions:



Extreme heights



Extreme widths

## ... IN INDUSTRIAL AND COMMERCIAL BUILDINGS

For loading areas



In logistic centres, where doors have to withstand tough conditions.

Outside roller shutters with roller box



Compliant with explosion protection standards and suitable for use in tight spaces.

Im Einzelhandel zur Ladensicherung z.B. in Passagen



Example of roller grilles.



Example of roller door.

Very little lateral and overhead space is required. The small shutter door is discretely hidden overhead in the false ceiling.

Ideal for underground garages



Roller grilles provide security, good ventilation and an unobscured view.



Optimum integration into existing constructions.

# ThermoTeck

- SPECIAL ROLLER SECTIONS
- IN LIGHTWEIGHT STEEL CONSTRUCTION
- GALVANIZED FINISH AND HEAT INSULATED

## High-grade steel

Galvanized finish with transparent protective top coat.

- Modern high-tech optics
- More economical than coated doors
- High load resistance and durability

Optional double-sided coil coating, see page 10

## Special section contour

Made of one continuous length of material for even greater strength and quiet operation.



## Double-skinned section

With CFC-free PUR (polyurethane) foam core for high robustness and heat insulation at the same time.

## Tightly rolled shutter curtain

Owing to the section geometry, the individual sections are wound up very tightly. In this way, the surface is protected and less headroom is required than in conventional door systems.



## Long-term durability thanks to multi-layer design

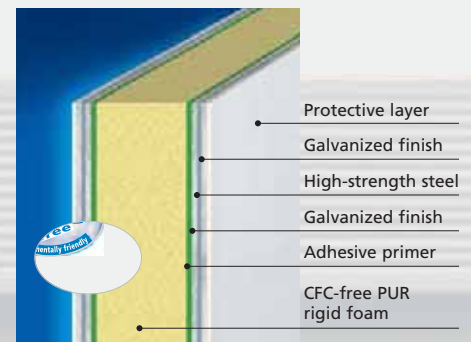

## Innovative micro-sections

In attractive optical design, highly robust and resistant to wear.

The roller door systems from Teckentrup feature perfectly matched system components such as a robust roller door curtain made of sheet steel, functional guide rails and efficient drive and control technology. Thanks to their optimum cross-sectional dimensions, the special ThermoTeck roller

sections can be wound up very tightly, thus protecting the door surface, saving space and keeping noise levels at a minimum. Topped with an excellent section design, the result is a roller door system which works reliably in every-day operation and still looks good after many years.

---

## ... HIGHLY ECONOMICAL

### **Spring mounted sections**

Stress, hectic, the pressure of deadlines or simple human carelessness – in the “heat of the moment” collisions between transport equipment and roller shutters can easily occur. With Teckentrup doors, however, such accidents seldom end in disaster as the flexible roller door sections can yield and spring back. And since the door sections are very robust, the sections are seldom damaged or have to be replaced.

# Roller door sections...

... FUNCTIONAL AND STYLISH

Insulated sections – provide effective heat insulation and resistance to high wind pressure



ThermoTeck with protective top coat or with double-skinned coil coating.



ThermoTeck with glazing



ThermoTeck with ventilation grille

**Stucco design:** insensitive aluminium surface for uncoated sections



4020



4020 with glazing



4020 Stucco

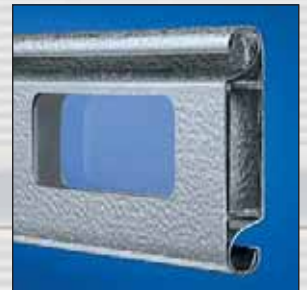

Stucco with glazing

Single-skinned sections – for use in non-heated buildings



6010

Modern door designs need not only satisfy safety and function-related requirements. In fact, door systems should also effect the overall optical impression of a building positively. The wide range of sections, glazing and colours available from Teckentrup leaves nothing to be desired in terms of creativity.

# Roller grilles

## GOOD VENTILATION, GOOD VISIBILITY AND OPTIMUM LIGHT PERMEABILITY

Teckentrup roller grilles are available in different designs, providing optimum ventilation, security and good visibility. The grille section 6010 visio, which features a very fine mesh-like design, also keeps out leaves, foliage and refuse. These grilles are recommended for use in shopping arcades for stores with large shop fronts, underground garages and indoor car parks. All of the roller grilles come with an automatic anti-lift device.



Roller grilles in diamond design TGX (aluminium).



Roller grilles in honeycomb design TGA (aluminium), TGS (steel), TGE (stainless steel).



Roller door section 6010 visio, Ventilation cross-section 30%.



Security for motor vehicle fleet.



Security and ventilation in underground garages.



Roller grilles for shop security - flexible designs which are well-suited to modern architecture.

# Individual solutions

WITH COLOUR AND LIGHT



## All the colours of the rainbow

The optical impression given by the doors of production halls is of great importance and can even be seen as the perfect medium for communicating a company's corporate design. The wide range of colours available from Teckentrup allows for a whole host of different door designs. Planning engineers have unlimited resources to draw on, enabling them to create a design that meets your individual style requirements.



## RAL colour choice



Choice of colours for door surfaces with coil coating on both sides: standard grey white (similar to RAL 9002) or white aluminium (similar to RAL 9006), traffic white (similar to RAL 9016), sepia brown 8014, and other shades based on RAL and NCS.

## Optimum light solutions

Glazing not only lets light into the hall, but is also a stylish design element.

All double-skinned Teckentrup sections are also available with transparent, insulated and shock-resistant polycarbonate double glazing.



## MATCHING SIDE DOORS

If necessary, different types of threshold-free side doors are available for access for persons to the building/hall.

Regardless of whether you opt for a fixed or rotating side element, security and functionality are always our top priority.



Roller grilles with side door in underground garages.



Door and side door with identical glazing.

# Functional Technology

## IDEALLY MATCHED



Operation occurs via handheld transmitters, induction loops, radar motion detectors, etc..

In addition to the convincing profile designs and first-class materials, the Teckentrup roller door components are also mightily impressive. Robust guide rails, wind hooks and perfectly harmonized drive and control units form the basis of our state-of-the-art roller door systems.

### Drive and control technology



TA direct mount drive with integrated safety brake mechanism



TK chain drive with separate safety brake mechanism



**AS 210 deadman control unit**  
Cost-effective solution with end limit switches in the drive (application: e.g. low usage hall doors). Also available with pulse operation.

The drive includes 2 floating end limit switches.



**CS 300 pulse comfort control unit**  
Microprocessor control unit with absolute encoder-evaluation. Simple but secure programming via 3-button navigation at the LCD monitor with multi-language plain text display, optional red-green "traffic light" indicator for door status messages, with optical warnings (application: e.g. underground car parks, car repair garages).



**MS 410 two-way traffic control unit**  
Microprocessor control unit with absolute encoder-evaluation (setting, maintenance, error diagnosis). Programming via 3-button navigation at the LCD monitor with multi-language plain text display (application: e.g. underground garages with lane control and roller grille with roll-up safety device)

The CS 300 and MS 410 control units have floating end limit switch signalling.



headroom from 480 mm to 800 mm

**Elaborate details**



Wind hooks guarantee safety even in event of high wind loads.

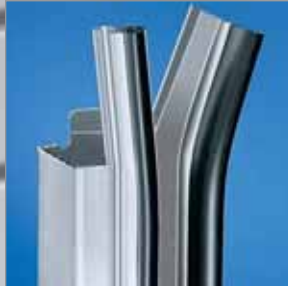

Functional, sturdy guide rails with plastic guide channels to improve running and sliding facilities.

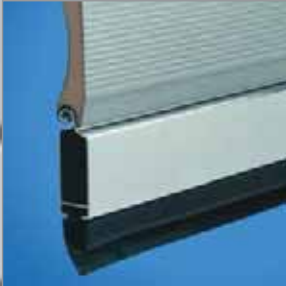

Bottom rail with a non-perishable seal made of elastic, frost-proof EPDM rubber. (The optical sensor for the safety edge mechanism can be retrofitted).

Lateral space requirements:  
 Space requirement at bracket end min. 180 mm  
 Space requirement at drive end min. 280 mm

**Quick and inexpensive installation:**



Drive and control units are supplied wired and ready for connection.

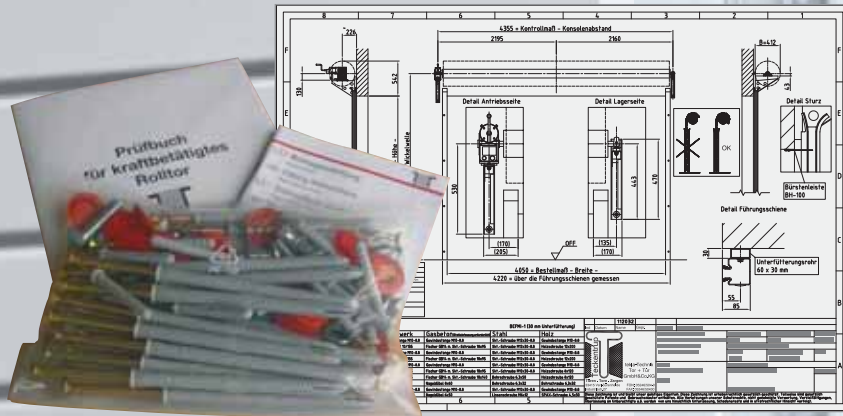

Compact installation pack: standard pack features all the necessary fixtures and fasteners, incl. individual installation diagram.

# ThermoTeck high-speed roller door

## FOR TIME AND ENERGY SAVINGS

### Uninterrupted operation

The ThermoTeck high-speed roller door from Teckentrup is intended for continuous operation in industrial applications. The high quality materials used and the standard safety features guarantee uninterrupted traffic flow.

Thanks to high-speed opening and closing, as well as insulated ThermoTeck sections, heat cannot escape from the hall, thus saving energy. What's more, glazing elements create a bright and pleasant working environment.

### Powerful system

- High-power drive for continuous use.
- Frequency converter control with 'soft' start/stop functions. Protects the material and guarantees long service life of the door.
- Greater protection against personal injury or material damage thanks to standard, integrated light barriers and safety edge.

- Average opening speed of up to 660 mm/sec.
- With max. dimensions of 5000 x 4500 mm.



# Roller door/roller grille with tubular drive

SUITABLE FOR USE IN TIGHT SPACES

## Integrated into the shaft

Teckentrup roller shutters and roller grilles with tubular drive are suitable for use when the door opening is rather small or no AC supply is available. The drive is integrated in the roller tube, taking up very little additional space.

This space-saving door design is designed for max. 1-2 movements per hour and is ideal for shop front applications or to protect production machinery.

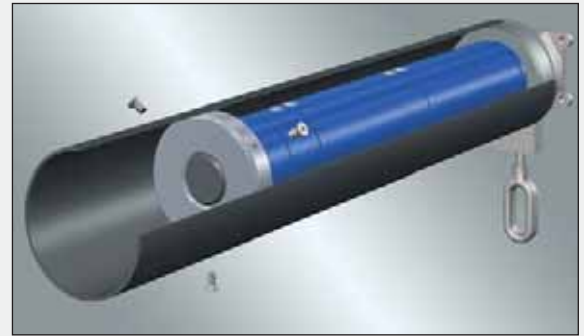

Drive integrated into shaft.



Also ideal for administrative or industrial annexes used as storerooms.



Low side space requirements.





Protection for production machinery.





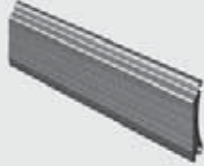
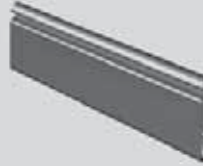



Shop front security.

# Types of doors and technical data

	ThermoTeck	4020	6010 Profil
			
<b>Door dimensions</b>			
Max width in mm	10 000	15 000	8 000
Max. height in mm	10 000	10 000	8 000
<b>Spatial requirements</b>			
See installation data	■	■	■
<b>Roller door curtain, material design</b>			
Steel, single-skinned	—	—	■
Steel, double-skinned	■	—	—
Aluminium, single-skinned	—	—	—
Aluminium, double-skinned	—	■	—
<b>Door leaf, surface design</b>			
Steel, galvanized	■	—	■
Steel, coil coating	■	—	—
Steel, powder coating	—	—	▲
Stainless steel	—	—	—
Aluminium, stucco design	—	■	—
Aluminium, natural finish	—	■	■
Aluminium, coil coating	—	■	■
Aluminium, powder coating	—	▲	▲
<b>Door leaf, weight</b>			
kg/m <sup>2</sup>	approx. 11	approx. 10	Alu 6 / Steel 16
<b>Side door</b>			
Same design as door leaf	▲	▲	▲
<b>Glazing</b>			
Rectangular glazing elements	▲	▲	—
<b>Gaskets/seals</b>			
Lintel seal	■	■	■
Floor seal	■	■	■
<b>Locking systems</b>			
Anti-lift device	▲	▲	—
Slide bolt	▲	▲	▲
Lockable floor section	▲	▲	▲
<b>Drive</b>			
Direct drive	■	■	■
Chain drive	▲	▲	▲
Tubular drive	■	—	■
<b>Safety features</b>			
Safety catch	■	■	■
Safety edge	▲	▲	▲
Light barrier for draw-in protection	▲	▲	▲
<b>Installation basis</b>			
Concrete	■	■	■
Steel	■	■	■
Masonry	■	■	■
Others upon request	▲	▲	▲

■ = standard ▲ = optional

TGS	TGA	TGV	TGE	TGX	6010 Visio
					
12 000 8 000	12 000 8 000	12 000 8 000	12 000 8 000	5 500 4 500	5 500 6 000
■	■	■	■	■	■
■	—	—	■	—	—
—	—	—	—	—	—
—	■	■	—	■	■
—	—	—	—	—	—
■	—	—	—	—	—
—	—	—	—	—	—
▲	—	—	—	—	—
—	—	—	■	—	—
—	—	—	—	—	—
—	■	■	—	■	■
—	—	—	—	—	■
—	▲	▲	—	▲	■
approx. 14	approx. 7	approx. 8	approx. 14	approx. 4	approx. 3,5
▲	▲	▲	▲	▲	▲
—	—	—	—	—	—
—	—	—	—	—	—
—	—	—	—	—	—
■	■	■	■	■	—
—	—	—	—	—	▲
▲	▲	▲	▲	▲	▲
■	■	■	■	■	■
▲	▲	▲	▲	▲	▲
■	■	■	■	■	■
▲	▲	▲	▲	▲	■
▲	▲	▲	▲	▲	■
■	■	■	■	■	■
▲	▲	▲	▲	▲	■
■	■	■	■	■	■
■	■	■	■	■	■
▲	▲	▲	▲	▲	▲

# All-round service

... FROM PLANNING TO  
INSTALLATION AND MAINTENANCE WORK



Besides guaranteeing first-rate product quality and flexibility in the development of customized solutions, Teckentrup also provides a comprehensive customer service. Whether it's planning and consultation, on-site customer care by field staff, fast and comprehensive delivery, or product and installation support courses, customer satisfaction is always top of the list of Teckentrup's priorities.

Our service for mandatory maintenance. We inform you of any upcoming inspection dates.



Improve your planning with our comprehensive installation data. Available at your request.

# Flexibility

... FOR TRANSPORT AND INSTALLATION

A modern enterprise should boast a high degree of flexibility right down to the very last detail. And Teckentrup is no exception. For at Teckentrup even the logistic possibilities are compliant

with the image of a contemporary "full-service enterprise". In fact, fast and intelligent transport logistics and easy installation are all part and parcel of our service.



The doors are packed compactly and are loaded onto special pallets that facilitate loading and transportation.



The shutter curtain can be placed onto pre-assembled consoles by a forklift truck.

# Teckentrup industrial doors for all your requirements

## WE OPEN THE DOORS FOR PROGRESS

Teckentrup was established in 1932 and has since become one of the largest manufacturers of doors and door systems in Europe, with production plants in Verl-Sürenheide (Administrative HQ) and Großzöberitz.

More than 15 locations in Germany, plus other partners in Europe and overseas together form an economic infrastructure that leaves nothing to be desired in terms of flexibility and customer care.

From the conceptual stage to innovation, the design stage to production, at Teckentrup, everything happens "under one roof".

Motivated and committed employees, the very latest CAD systems and computer-controlled production systems are the keys to a secure future.



Sectional doors



Roller shutters



Folding doors



Multi-purpose sliding doors



Fire doors



High-speed sheet doors

# European scope...

... WE DON'T LET OUR CUSTOMERS DOWN

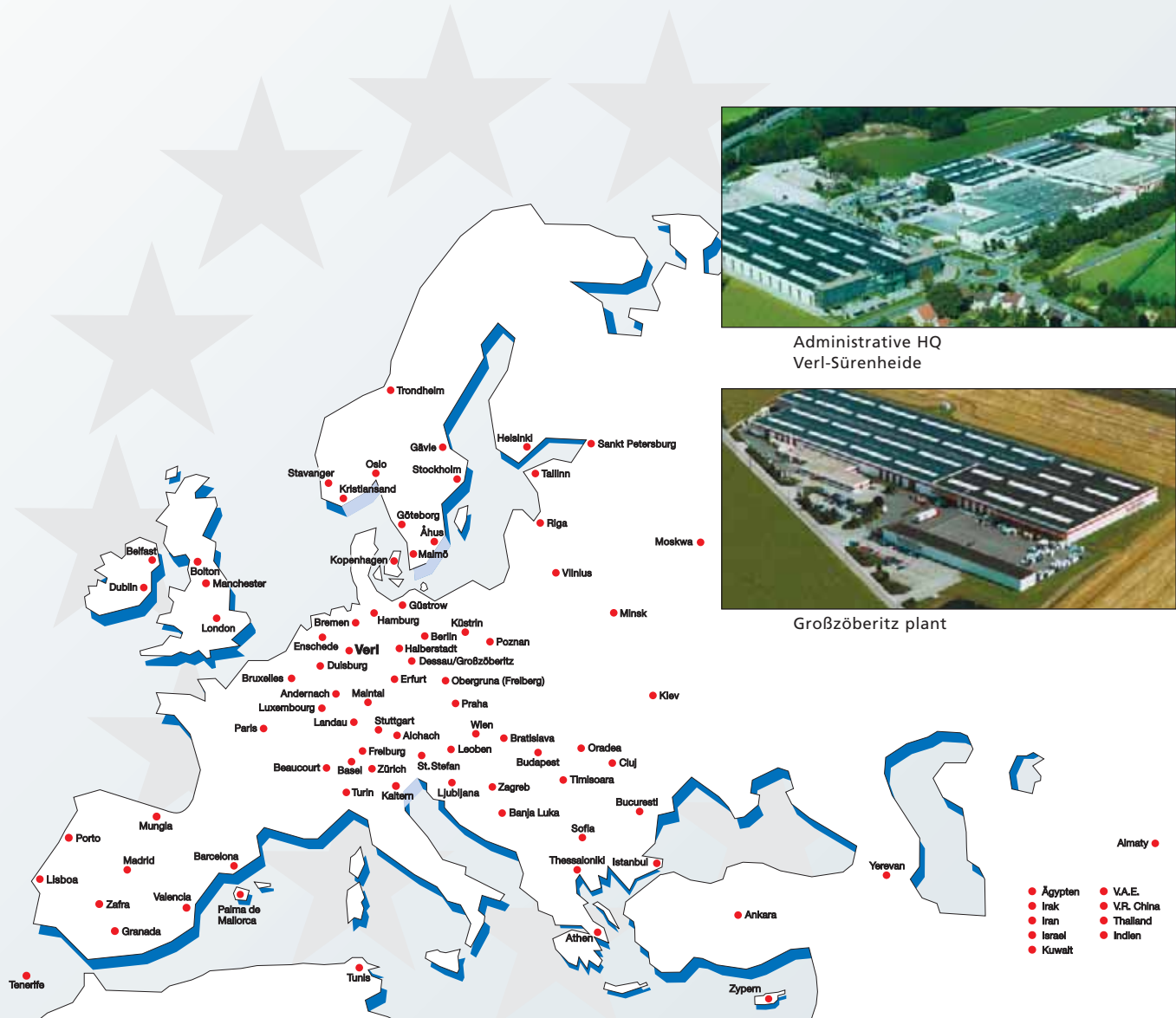

Internet: [www.teckentrup.biz](http://www.teckentrup.biz)

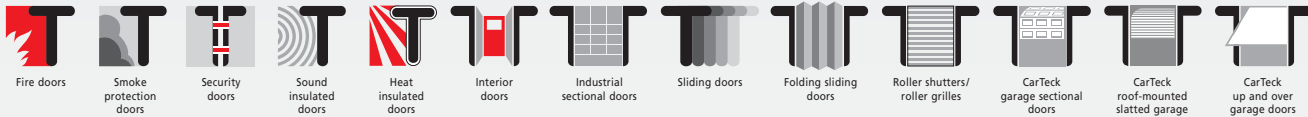

Subject to technical modifications.  
01/09/08 (GB) 121.488  
All illustrations contained in this brochure are solely intended to highlight individual product features and may therefore not necessarily be identical with the standard product version.

WE OPEN THE DOORS FOR PROGRESS

